

TM4-TM5 CRB MACHINE INSTRUCTION MANUAL

Manual de Instrucciones Máquina de limpieza CRB TM4-TM5



CONTENT



- 02** Testimonial and educational content
- 03-04** Warranty
- 05-07** Warnings and safety precautions
- 09-18** How to assemble the machine
 - Parts blueprint TM4
 - Transport trolley TM4-TM5
 - Starting the machine
 - Motor safety Switch
- 19-24** Spare parts TM4/ TM5
- 25** TM4/ TM5 Wire diagram

Testimonial

"Great quality products and excellent customer service. Looking forward to doing more business with them".

-Daniela Cano (Owner of Cleaning Depot).



Educational Content

Join to our page & Facebook group

This type of content will help you to improve the way you clean and make money. It is hard to find a good source about cleaning with a CRB in a neutral tone. CRB low moisture cleaning is growing and is becoming the go-to cleaning method for carpets and hard floors in the future.

Este tipo de contenido lo ayudará a mejorar la forma en que limpia y gana dinero. Es difícil encontrar una buena fuente sobre la limpieza con un CRB en un tono neutro. La limpieza de baja humedad CRB está creciendo y se está convirtiendo en el método de limpieza para alfombras y pisos duros.



Subscribe to our youtube channel

Find educational content with posts about our machines and products. This will help the users of our products, which will make our products more effective and last longer.

Encuentre contenido educativo con publicaciones sobre nuestras máquinas y productos. Esto ayudará a los usuarios de nuestros productos, lo que los hará más efectivos y durarán más.



Connect to our business network on LinkedIn

We look forward to the bright future of our industry while it trends towards an eco-friendly world.

Esperamos con ansias el futuro brillante de nuestra industria mientras tiende hacia un mundo ecológico.



**SURFACE CLEANING
INNOVATIONS**
Redefining clean



WARRANTY

GARANTÍA



WARRANTY CERTIFICATE

Model _____ Date _____

Serial number _____

All CRB Clean Inc machines come with a 1/2 limited (1 year on the machine and 2 years on the motor). The warranty applies to all original CRB Clean Inc Extraction Cleaning Machines used in the U.S. when purchased from a CRB Clean Inc Authorized Distributor, Affiliate or directly from the CRB Clean Inc United States, machines are warranted by the local Distributors.

This machine is warranted to be free from defects in materials and workmanship when used solely for the purpose of pile lifting, encapsulation, agitation, compound of carpets or hard floors using. This Warranty applies to the original purchaser only. If the machine is sold, transferred, traded or lost, this Warranty shall be void and no longer valid.

In the event of failure of a part or parts within 1 year of the machine or 2 years of the motor from original purchase date and upon inspection by the Manufacturer or Manufacturer's Representative to determine that failure is due to defective materials or workmanship, such defective will be repaired or replaced at the Manufacturer's expense.

This warranty neither covers damages resulting from catastrophe, fault, or negligence of third parties including, but not limited to, user neglect or abuse, or the shipping damage, nor does it cover expendable parts subject to normal wear. Any modification to the equipment by the customer will void the Warranty and CRB Clean Inc will have no further obligation to the Purchaser under this Warranty. Parts that are not considered under warranty and are classified as maintenance/wear and tear include, but are not limited to:

- | | | |
|-----------------|----------------------|--------------------|
| ·Gears. | ·Rubber bumpers. | ·Screws. |
| ·Brushes. | ·Handle stop. | ·Protective plate. |
| ·Capacitors. | ·Handle stop spring. | ·Brush axles. |
| ·Ball bearings. | ·Cable holders. | ·Outlet cover. |

If one of the maintenance/wear and tear parts breaks within 90 days, we kindly request that you provide the manufacturer with the serial number and a detailed report of the issue before any action is taken. A response will be provided within 1-2 business days.





WARNINGS

ADVERTENCIAS

Important precautions and safety information: Review these instruction before operation of equipment

Precauciones importantes e información sobre seguridad: revisar estas instrucciones antes de operar el equipo

- 1.** **Keep out of reach of children**
Mantener fuera del alcance de los niños
- 2.** **Close supervision is necessary when any appliance is used by or near children.**
Se requiere supervisión cuando cualquier aparato sea utilizado por, o cerca de niños.
- 3.** **Do not allow the carpet and hard floor cleaning machine to be used as a toy or to run attended at any time.**
No permitir que la alfombra y piso duro de la máquina de limpieza sea para ser utilizado como un juguete o para ser usado sin supervisión.
- 4.** **Keep hair, loose clothing, fingers, feet and all parts of body away from openings, rotating brushes and other moving parts.**
Mantener el cabello, la ropa suelta, los dedos, los pies y todas las partes del cuerpo alejados de las aberturas, cepillos giratorios y otras partes móviles.
- 5.** **Do not operated machine with bare feet or when wearing open toed shoes or sandals.**
No hacer uso de la maquina con los pies descalzos o con zapatos o sandalias de punta abierta.
- 6.** **Do not pick up anything that is burning or smoking such as cigarettes, matches or hot ashes.**
No recoger nada que esté ardiendo o desprendiendo humo como cigarrillos, fósforos o cenizas calientes.
- 7.** **Do not use to pick up flammable or combustible materials such as but not limited to; gasoline or alcohol or use in areas where they may be present.**
No utilizar para recoger materiales inflamables o combustibles tales como, pero no limitados a; gasolina o alcohol en áreas en las que pueden estar presentes.
- 8.** **Avoid picking up hard, sharp objects with the cleaner, since they may damage the machine.**
Evitar recoger objetos duros o afilados con la aspiradora, ya que pueden dañar la máquina.
- 9.** **Always turn off the machine before connecting or disconnecting the power cord to the power outlet.**
Apagar siempre la máquina antes de conectar o desconectar el cable a la toma de corriente.
- 10.** **Use extra care when cleaning stairs.**
Tener cuidado especial al limpiar escaleras.
- 11.** **Do not put any objects into openings or near brushes.**
No colocar ningún objeto en las aberturas o cerca de los pinceles.
- 12.** **Do not use the machine with any blocked opening; keep free of dust, lint, hair or anything that may reduce brush action.**
No utilizar la máquina con ninguna abertura bloqueada; manténgala libre de polvo, pelusa, pelo o cualquier cosa que pueda reducir la acción del cepillo.
- 13.** **Do not pull or carry by cord, use cord as a handle, close door on cord or pull cord around sharp edges or corners.**
No tirar ni llevar el cable como manillar, usar el cable como un asa, cerrar la puerta sobre el cable o tirar del cordón alrededor de bordes o esquinas afiladas.
- 14.** **Do not run the machine over the cord and keep it away from heated surfaces.**
No dejar pasar la maquina por encima del cable, mantenerlo alejado de superficies calientes.
- 15.** **Always disconnect cord from electrical outlet before servicing the cleaner or when not in use.**
Desconecte siempre el cable de la toma eléctrica antes de reparar el limpiador o cuando no esté en uso.
- 16.** **Unplug the machine when not in use after all controls have been turned off.**
Desenchufe la máquina cuando no esté en uso después de que todos los controles se hayan apagado.

17. Use only the carpet and hard floor cleaning machine for its intended uses described in the instructions. Use only attachments recommended by CRB Clean Inc, others may cause hazards. Always wash hands after handling chemicals or cleaning materials.

Utilizar la máquina de limpieza CRB sólo en alfombras y en pisos duros, esta es únicamente para sus usos descritos en las instrucciones. Utilizar sólo los accesorios recomendados por CRB Clean Inc, otros pueden causar peligro. Siempre lávese las manos después de manipular productos químicos o materiales de limpieza.

18. Do not use with the damaged with damaged cord or plug. If machine has been dropped, damaged, left outdoors or dropped into water, take it to CRB Clean Inc service center or authorized CRB Clean Inc warranty service dealer.

No utilizar con el cable o enchufe dañado. Si la máquina se ha caído, dañado, llevarlo al centro de CRB Clean Inc donde pueda contar con un distribuidor autorizado de servicio de garantía.

19. To unplug, grab the plug not the cord and disconnect and never handle plug with wet hands.

Para desenchufar, tome el enchufe, no el cable, desconecte y nunca toque el enchufe con las manos mojadas.

Follow these instructions to reduce the risk of fire, electric shock or injury
Siga estas instrucciones para reducir el riesgo de incendio, descargas eléctricas o lesiones

Information

Please enter the COMPLETE model and serial numbers in the spaces provided.

Model _____

Serial number _____

Hitch: Attach your sales receipt to the owner's manual/ instructions. Verification of date of purchase may be required for the warranty service of your CRB Clean Inc product.

Sugerencias: Adjunte su recibo de compra a este Manual del propietario. Para obtener el servicio de garantía de su producto CRB Clean Inc. Puede requerirse la verificación de la fecha de compra.

Be sure to fill out and return the product registration card included with your cleaning machine. (see back cover)

Asegúrese de completar y devolver la tarjeta de registro del producto incluida con su máquina de limpieza. (ver contraportada)

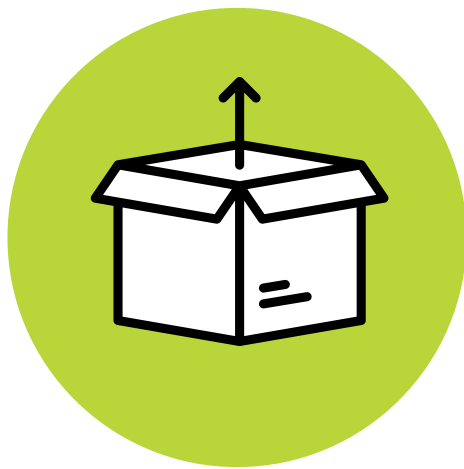

ASSEMBLY

MONTAJE

Parts blueprint TM4

Plano de piezas TM4

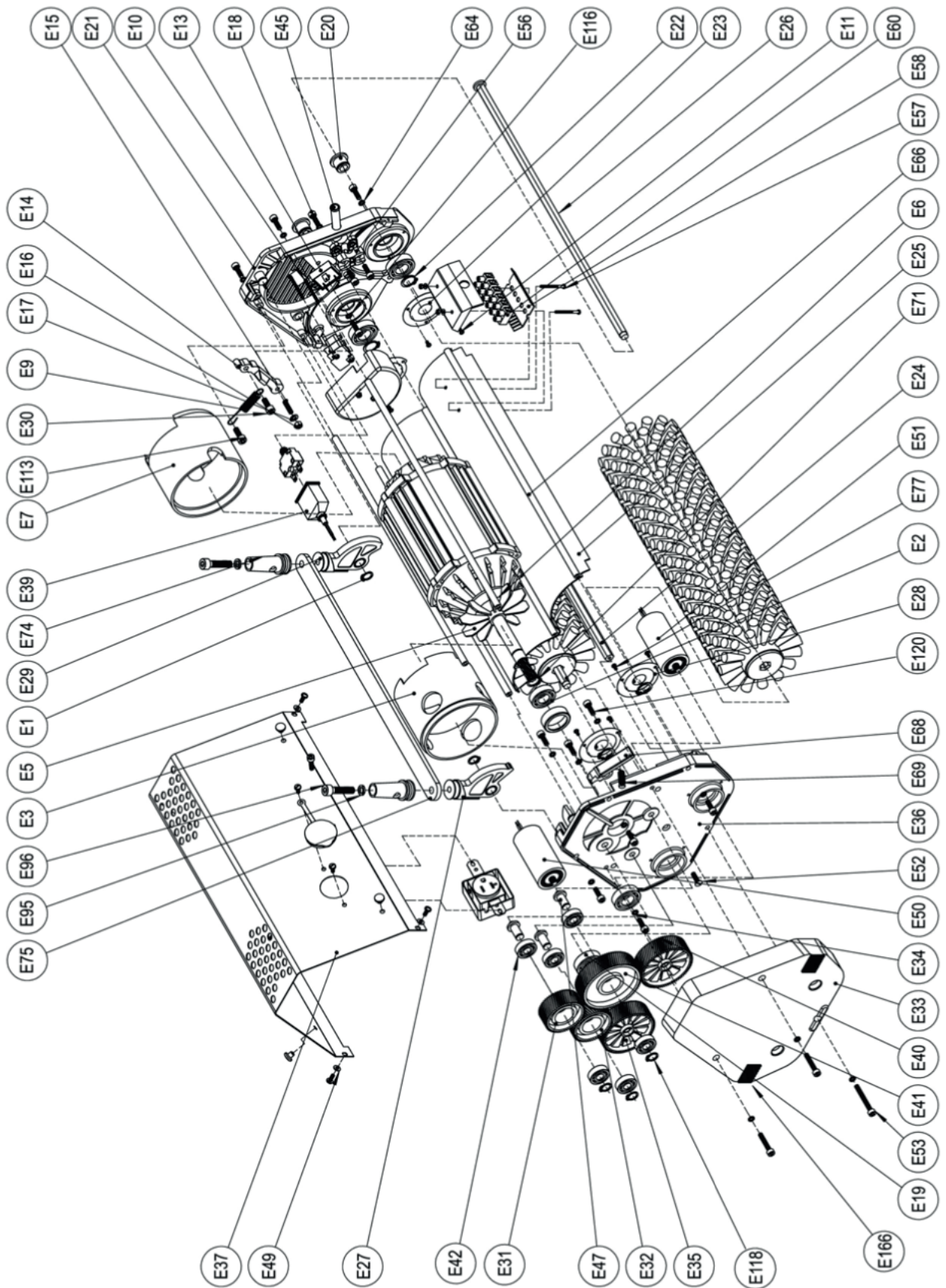

Transport trolley TM4 - TM5

Carretilla de transporte TM4 - TM5



X4E



X4B/W



X4B



E8



01

How the CRB Machine arrives
Como llega la máquina CRB



02

Open Box, (always be careful not to cut yourself in removing any packaging)
Abra la caja, (siempre tenga cuidado de no cortarse al quitar cualquier embalaje)



03

Remove content
Retirar el contenido



04

Remove Protective Wrapping on Each Piece
Retire la envoltura protectora de cada pieza



05

CRB Machine parts set
Conjunto de piezas de la máquina CRB

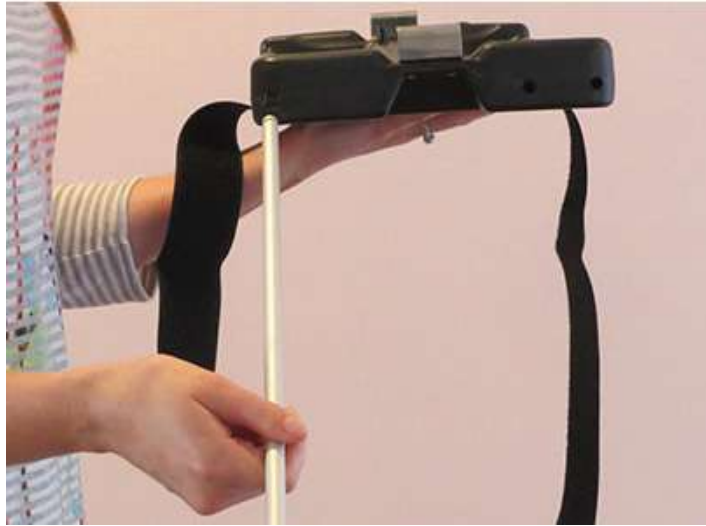

06

Assemble the Transport Trolley, first put axle into a single hole
Ensamble el carro de transporte, primero coloque el eje en un solo orificio



07

Attach Wheels to Axle, push in clip to lock wheels, make sure they lock
Fije las ruedas al eje, presione el clip para bloquear las ruedas, asegúrese de que se bloqueen



08

Insert front Bar on from of Transport Trolley
Inserte la barra delantera desde el carro de transporte

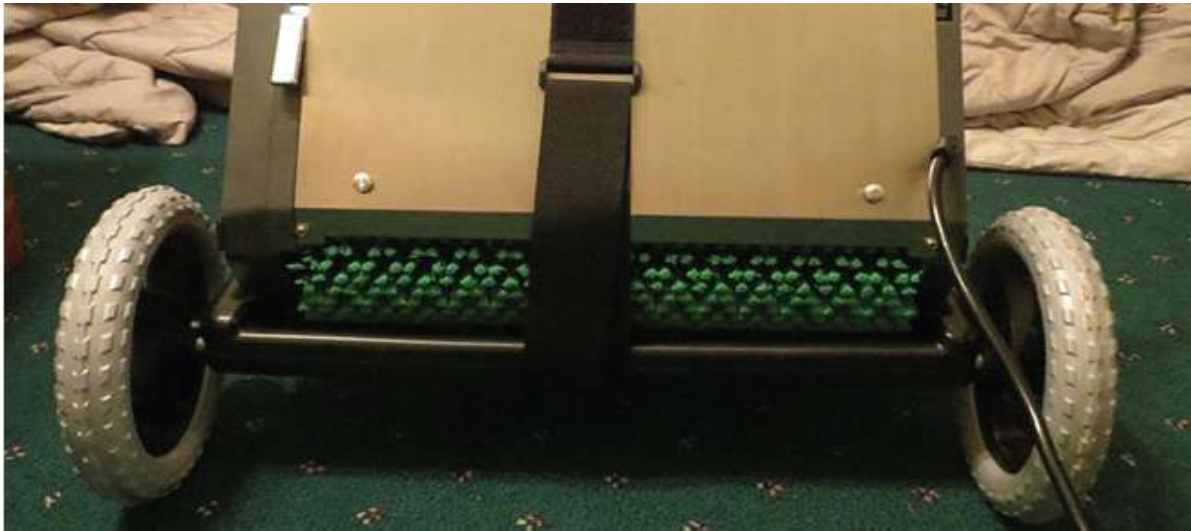

09

Put CRB Machine on Transport Trolley
Coloque la máquina CRB en el carro de transporte



10

Attach Connecting Bar on Top of CRB Machine – Snap Buttons facing back
Coloque la barra de conexión en la parte superior de la máquina CRB: los botones a presión están orientados hacia atrás

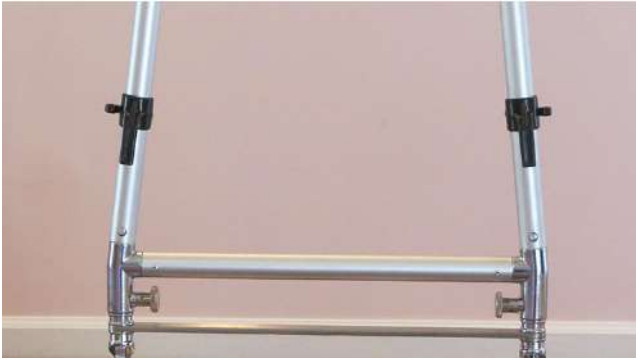

11

Attach each side of Handle Bars – Push in Snap Buttons to attach – Cord clips are outside
Fije cada lado de las barras del manillar - Presione los botones a presión para unir - Los clips del cable están afuera



12

Attach Top Handle Bar – Push in Snap Buttons to attach
Fije la barra de la manija superior: presione los botones a presión para fijar



13

Complete CRB Machine
Máquina CRB completa

Attaching Accesorios



14

Attaching Dust Cover – Pushover Slots and Push Right to Clicked Button
Colocación de la cubierta antipolvo: ranuras de empuje y empuje el botón derecho al clic.



15

Removing Dust Cover – Push Button & Slide Left
Desmontaje de la cubierta antipolvo: botón y deslice hacia la izquierda.

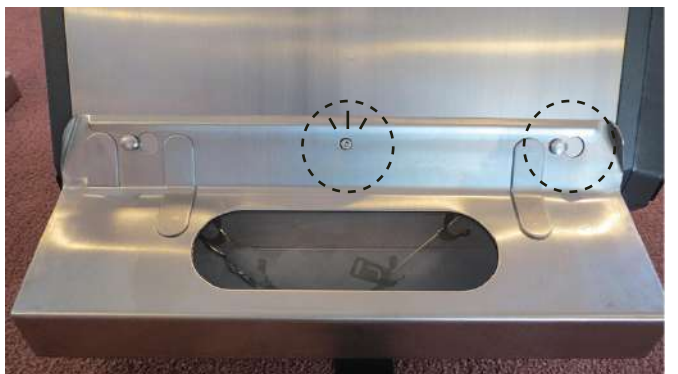
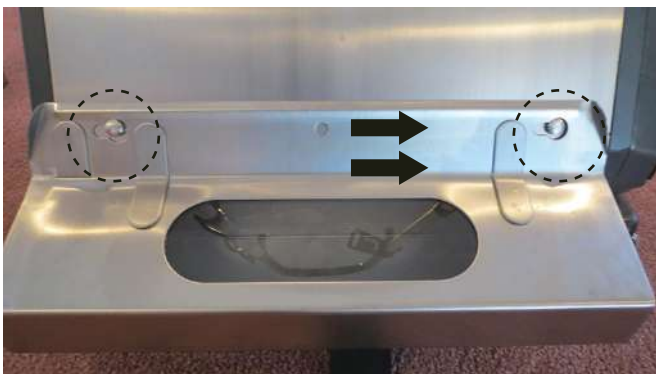

16

Attaching Receptacles - Pushover Slots and Push Right to Clicked Button
Colocación de receptáculos: ranuras de empuje y empuje el botón derecho al clic

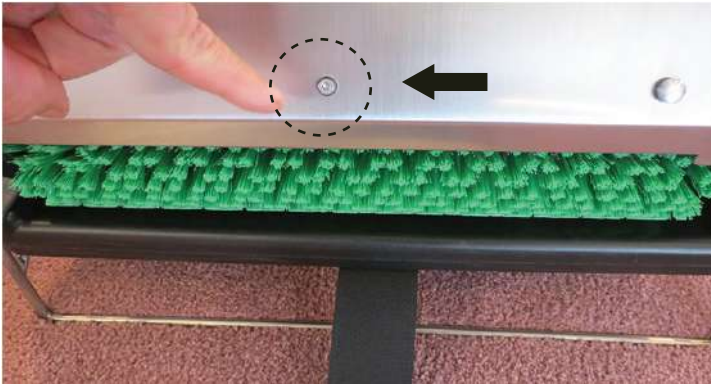

17 Removing Receptacles – Push Button and slide Left
 Extracción de receptáculos: presione el botón y deslícelo hacia la izquierda

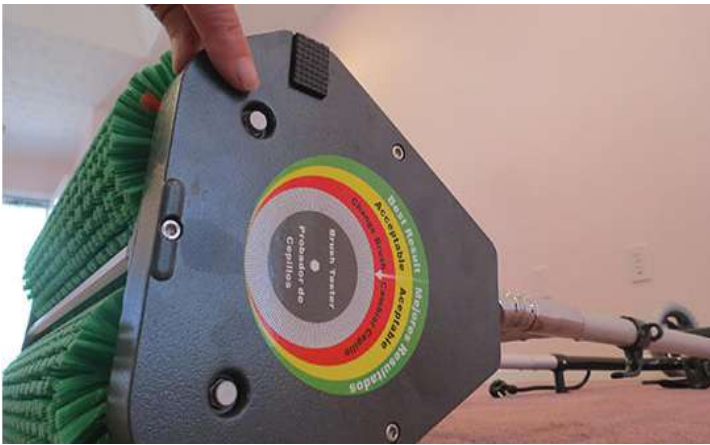

18 Push End of Bar and Slide Out
 Empuje el extremo de la barra y deslice hacia afuera

19 Align Bar & Brush and Push until it slides all the Through – DO NOT FORCE
 Alinee la barra y el cepillo y empuje hasta que se deslice completamente- NO FUERCE



DO NOT put the brush axles in backwards as this will damage the flange and gears.
 NO coloque los ejes del cepillo hacia atrás ya que esto dañará la brida y los engranajes.



20

Mount the handle on the bolt and connect both parts together.

Monte el mango en el perno y conecte ambas partes juntas.



Starting the machine Encienda la maquina

Push down the start lever on lower left side with your left foot. The motor will automatically start when the handle is pulled back. Place the electric cable in the clip provided on the handle. This will help to protect the cable from the rotating brushes.

Apretar con el pie el interruptor de seguridad e inclinar el manillar. Enganchar el cable eléctrico en la pinza provista en el manillar. Esto lo protegerá de los cepillos rotativos.



Motor Safety Switch Dispositivo de Sobrecarga

The safety switch automatically cuts off the electricity if the motor overloads. After approx. 30 seconds press the button inwards and continue to work.

En caso de sobrecarga, el dispositivo cortará automáticamente el suministro eléctrico. Después de 30 segundos apretar el botón y continuar con el trabajo.









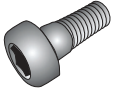

Spare parts TM4/ TM5

Partes de repuesto TM4/ TM5

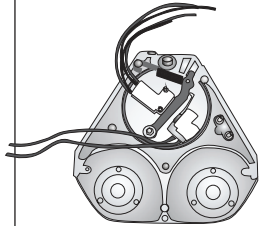
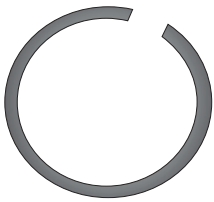
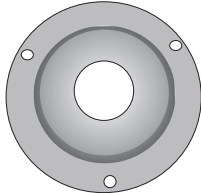
<p>E 1</p> 	<p>E 2</p> 	<p>E 3</p> 	<p>E 5</p> 
<p>Snap Ring A1</p>	<p>Ball bearing 6002</p>	<p>TM4/TM5 Distance piece G</p>	<p>Ventilator</p>
<p>E 6</p> 	<p>E 7</p> 	<p>E 8</p> 	<p>E 9</p> 
<p>TM4/ TM5 Motor</p>	<p>TM4/ TM5 Distance piece E</p>	<p>TM4/ TM5 Transport Trolley Complete</p>	<p>Extension spring</p>
<p>E 10</p> 	<p>E 11</p> 	<p>E 12</p> 	<p>E 13</p> 
<p>Worm screw M3 X 44</p>	<p>Nut M3</p>	<p>Spring Ring M3</p>	<p>Electronic Micro switch</p>
<p>E 14</p> 	<p>E 15</p> 	<p>E 16</p> 	<p>E 17</p> 
<p>Switchpar</p>	<p>M5 X 20 Screw</p>	<p>Nut M5 Self Lock</p>	<p>Washer M5</p>

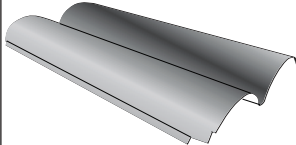
Spare parts TM4/ TM5

Partes de repuesto TM4/ TM5

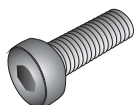
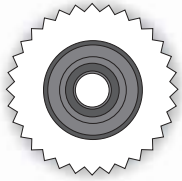
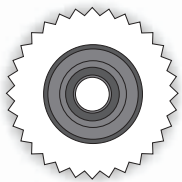
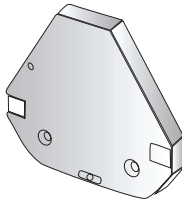
<p>E 18</p> 	<p>E 19</p> 	<p>E 20</p> 	<p>E 21</p> 
<p>Cylinder head screw M5 x 16</p>	<p>Ball bearing 6003</p>	<p>Flange</p>	<p>Housing unit E complet</p>
<p>E 22</p> 	<p>E 23</p> 	<p>E 24</p> 	<p>E 25</p> 
<p>Retaining Ring A 17</p>	<p>Protective plate</p>	<p>TM4/ TM5 Motor stud</p>	<p>TM4/ TM5 Brush cover</p>
<p>E 26</p> 	<p>E 27</p> 	<p>E 29</p> 	<p>E 30</p> 
<p>TM4/ TM5 Brush axel</p>	<p>Handle connector lower part G</p>	<p>Handle connector lower part E</p>	<p>Screw M6 x 16</p>
<p>E 31</p> 	<p>E 32</p> 	<p>E 33</p> 	
<p>Gear 48 right with bearings</p>	<p>Gear 48 left with bearings</p>	<p>Gearcover</p>	

Spare parts TM4/ TM5

Partes de repuesto TM4/ TM5

<p>E 34</p> 	<p>E 35</p> 	<p>E 36</p> 	<p>E 37</p> 
<p>Lock washer M5</p>	<p>Gear 66 right</p>	<p>Housing unit G complete</p>	<p>TM4/ TM5 Motor cover</p>
<p>E 39</p> 	<p>E 40</p> 	<p>E 41</p> 	<p>E 42</p> 
<p>Thermorelay</p>	<p>Gear 66 left</p>	<p>Gear 73 right with bearings</p>	<p>Ball bearing 6000</p>
<p>E 45</p> 	<p>E 46</p> 	<p>E 47</p> 	<p>E 49</p> 
<p>Grommet</p>	<p>Pig Tail Cable</p>	<p>Bearing pin</p>	<p>Screw M4 X 12</p>
<p>E 50</p> 	<p>E 51</p> 	<p>E 52</p> 	<p>E 53</p> 
<p>Start Capacitor</p>	<p>Run Capacitor</p>	<p>Cylinder head screw M5 x 30</p>	<p>Cylinder head screw M5 x 45</p>

Spare parts TM4/ TM5

Partes de repuesto TM4/ TM5

<p>E 54</p> 	<p>E 56</p> 	<p>E 57</p> 	<p>E 58</p> 
<p>Clamp strip</p>	<p>Cable clamp</p>	<p>Screw M3 x 30</p>	<p>Wire fixing plate</p>
<p>E 60</p> 	<p>E 62</p> 	<p>E 63</p> 	<p>E 64</p> 
<p>Terminal block</p>	<p>Worm screw</p>	<p>Nut M4</p>	<p>Lock washer</p>
<p>E 66</p> 	<p>E 68</p> 	<p>E 69</p> 	<p>E 71</p> 
<p>TM4/ TM5 Cable protector</p>	<p>Handle stop</p>	<p>Handle stop - spring</p>	<p>Snap ring A 15</p>
<p>E 74</p> 	<p>E 75</p> 	<p>E 77</p> 	<p>E 79</p> 
<p>TM4/ TM5 Handle connector upper part</p>	<p>TM4/ TM5 Flat bar</p>	<p>Screw M3 x 6</p>	<p>TM4/ TM5 Handle, upper part</p>

Spare parts TM4/ TM5

Partes de repuesto TM4/ TM5



E 83

TM4/ TM5 Low Handle With Cross Bar

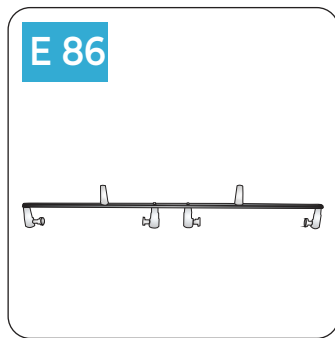

E 86

TM4/ TM5 Tandem bar



E 88

TM4/ TM5 Handle complete



E 96

TM4 Cylinder Head Screw M8 x 25

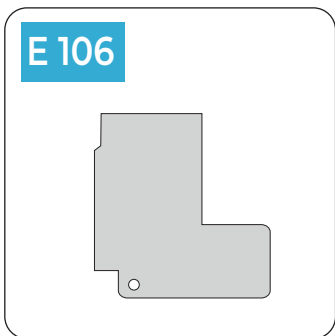

E 106

Isolation plate



E 113

Cylinder head screw M6 x 14



E 116

Spring Ring M



E 117

Screw M5 X 12



E 118

Snap ring A 10



E 120

Screw M6 X 14

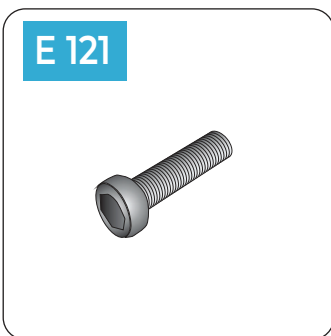

E 121

Screw M5 X 30



E 122

Handle lower part- Left



E 123

Handle lower part- Right



E 126

360 Cable holder

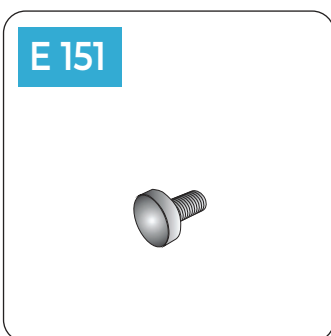

E 151

Nut & Bolt for renovator

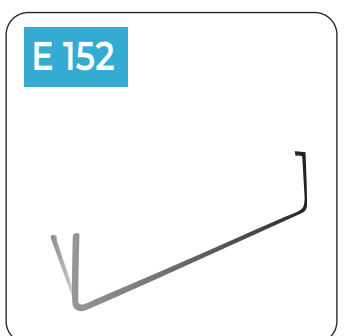

E 152

TM4/ TM5 Front up right trolley

Spare parts TM4/ TM5

Partes de repuesto TM4/ TM5

E 153



Big Trolley wheels

E 155



Trolley Belt

E 158



TM4/ TM5 Axel for trolley

E 163



Trolley metal bucket

E 164



Trolley plastic pins

E 165



Terminal Read Shrouds

E 166



Machine side bumpers

E 167



Plastic splash proof electronics cover

PC50



50ft Extension Cord
Black

X4B



TM4 Dust Cover
without wheels

X4B/W



TM4 Dust Cover
with wheels

X4E



TM4 Renovator
collection Tray

X5B



TM5 Dust Cover
without wheels

X5B/W



TM5 Dust Cover
with wheels

X5E



TM5 Renovator
collection Tray

TM4/ TM5 Wire diagram

Diagrama de cableado TM4/ TM5

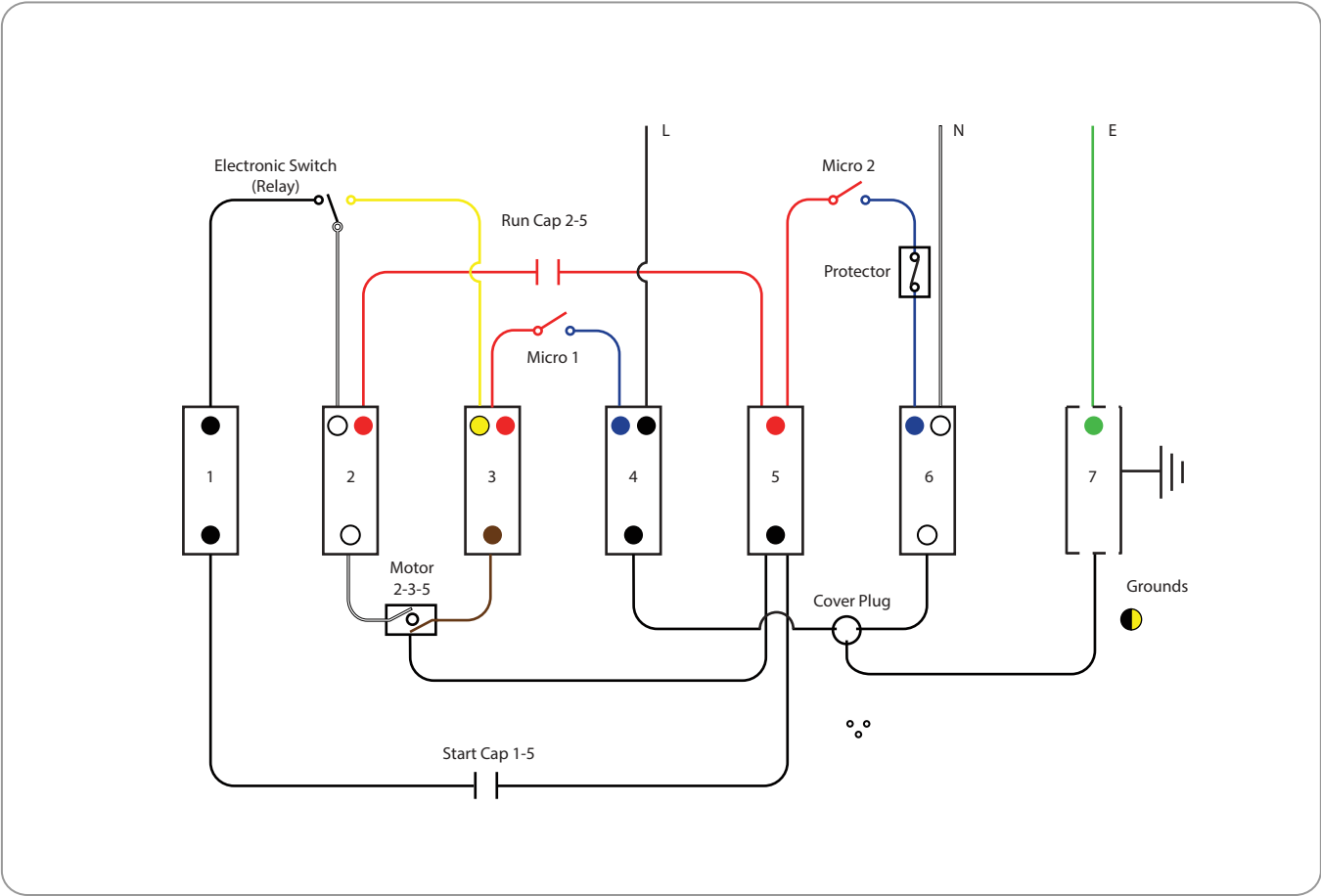

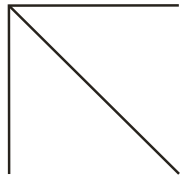

CRB Cleaning Systems

CRB Cleaning Systems guarantees efficient carpet and hard surface cleaning solutions to all our customers with our state of the art CRB machinery and chemistry providing our clients with 100% guaranteed satisfaction.